

# Profile TRIADA

Ref. B4476

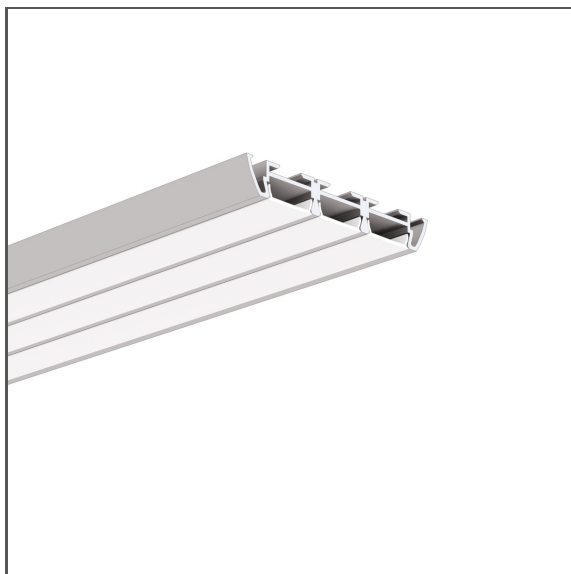

- High lumen output
- Smooth profile walls
- Wide range of accessories
- Small bending radius

## APPLICATION

- main and functional lighting

## MONTAGE

- suspended or to the surface, using a dedicated mounting track, dedicated accessories or properly selected screws
- can be easily connected into runs

## TECHNICAL DRAWING

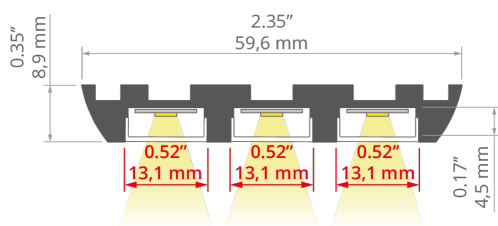

## TECHNICAL SPECIFICATIONS

Material	aluminum	Length		Ref	
Color	■ silver anodized	1000 mm		B4476ANODA_1	
With the possibility of sealing up to IP	20, 67	2005 mm		B4476ANODA_2	
Possible shapes of the luminaire	polygonal	3010 mm		B4476ANODA_3	
LED gluing width A	12 mm				
LED gluing width B	12 mm				
LED gluing width C	12 mm				
Possibility of bending	yes				
Minimum external radius	200 mm				
Minimum internal radius	200 mm				
Number of LED strips A (8 mm wide)	1				
Number of LED strips B (8 mm wide)	1				
Number of LED strips C (8 mm wide)	1				

# Profile TRIADA

Ref. B4476

Width	59.6 mm
The cover is cut to the length of the profile	yes
Can be easily connected into runs	yes
Main lighting	yes
Functional lighting	yes
Wire out back of extrusion	yes

## SAMPLE PROJECTS

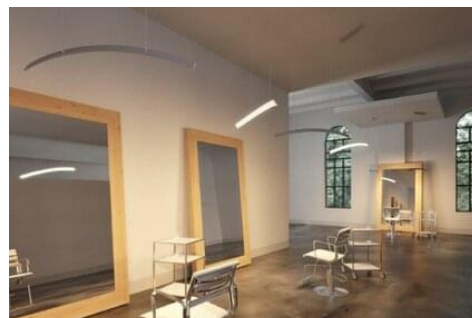
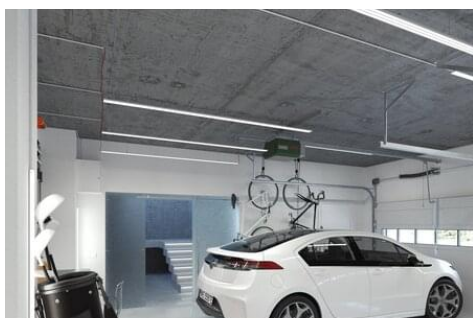

## RELATED PROFILES



**TETRA-43**  
W4476



**TETRA-78**  
W4508

## COVERS

NAME	MATERIAL	MATERIAL TRANSMITTANCE	COLOR	REF.
KA-PRO-12	PC	74	<input type="checkbox"/> frosted	17066
		94	<input checked="" type="checkbox"/> clear	17067
KA-12	PC	69	<input type="checkbox"/> frosted	17078
		94	<input checked="" type="checkbox"/> clear	17079
HS-12	PC	73	<input type="checkbox"/> frosted	00157
		94	<input checked="" type="checkbox"/> clear	00158

## END CAPS

NAME	MATERIAL	COLOR	REF.
TRIADA	PP	<input checked="" type="checkbox"/> gray	00090
		<input type="checkbox"/> silver	24056

## LED



**K-1210-12V**  
K-1210-12V

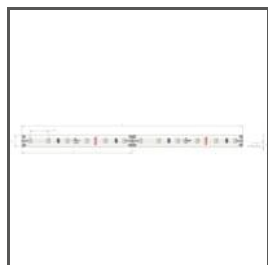

**K-1210-24V**  
K-1210-24V



**K-1220-12V**  
K-1220-12V



**K-1220-24V**  
K-1220-24V



**K-1275-12V**  
K-1275-12V



**K-1275-24V**  
K-1275-24V

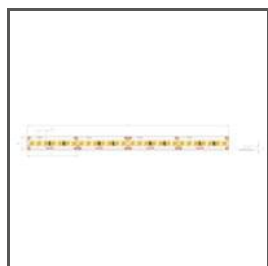

**K-1820-HD-24V**  
K-1820-HD-24V

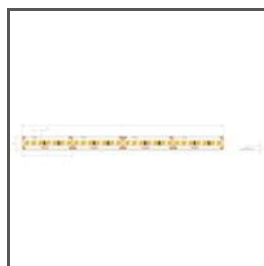

**K-1910-HD-24V**  
K-1910-HD-24V

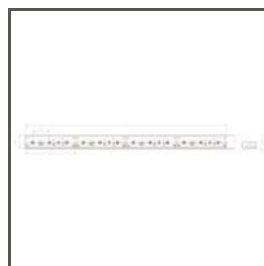

**WP-K-1210-12V**  
WP-K-1210-12V

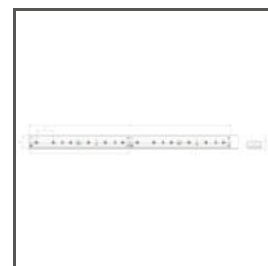

**WP-K-1210-24V**  
WP-K-1210-24V

# Profile TRIADA

Ref. B4476



**WP-K-1220-12V**  
WP-K-1220-12V

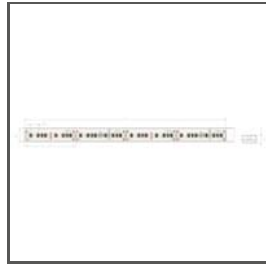

**WP-K-1220-24V**  
WP-K-1220-24V

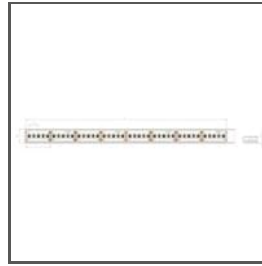

**WP-K-1275-12V**  
WP-K-1275-12V

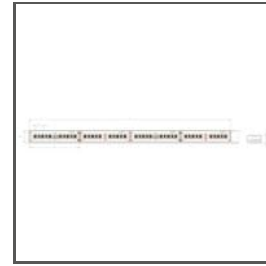

**WP-K-1275-24V**  
WP-K-1275-24V



**WP-K-1910-HD-IP65-24V**  
WP-K-1910-HD-IP65-24V



**WP-K-1220-IP65-12V**  
WP-K-1220-IP65-12V

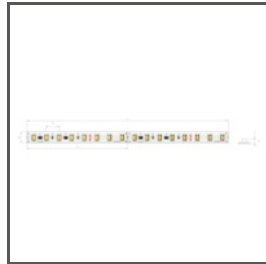

**K-HE-0480-HD-24V**  
K-HE-0480-HD-24V



**K-HE-0960-HD-24V**  
K-HE-0960-HD-24V



**K-HE-1440-HD-24V**  
K-HE-1440-HD-24V

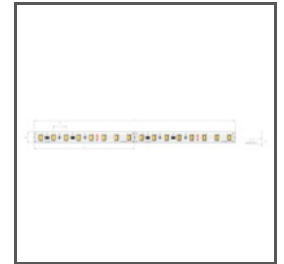

**K-HE-1920-HD-24V**  
K-HE-1920-HD-24V

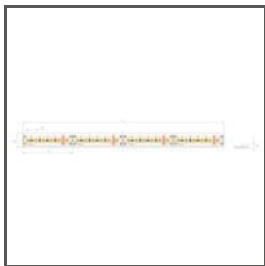

**K-LR-1000-24V**  
K-LR-1000-24V

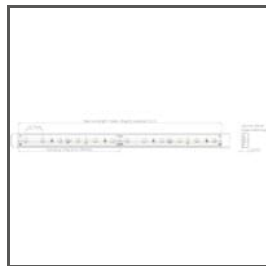

**WP-K-CR-1210-24V**  
WP-K-CR-1210-24V



**WP-K-CR-1220-24V**  
WP-K-CR-1220-24V



**WP-K-CR-1275-24V**  
WP-K-CR-1275-24V

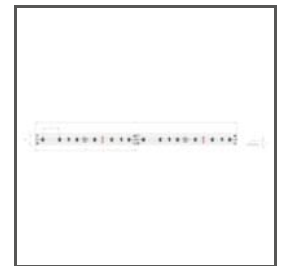

**K-CR-1210-24V**  
K-CR-1210-24V



**K-CR-1220-24V**  
K-CR-1220-24V



**K-CR-1275-24V**  
K-CR-1275-24V

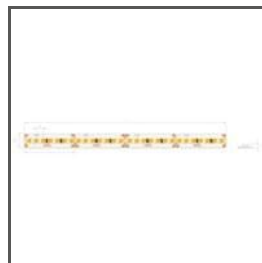

**K-CR-1820-HD-24V**  
K-CR-1820-HD-24V

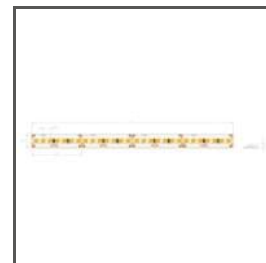

**K-CR-1910-HD-24V**  
K-CR-1910-HD-24V

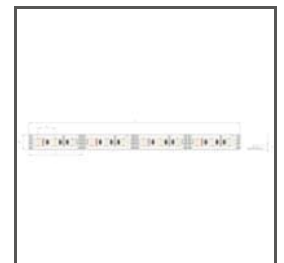

**K-1275-RGB-12V**  
K-1275-RGB-12V

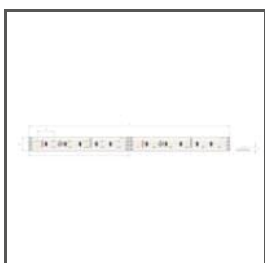

**K-1275-RGB-24V**  
K-1275-RGB-24V



**K-1530-RGB+W-24V**  
K-1530-RGB+W-24V

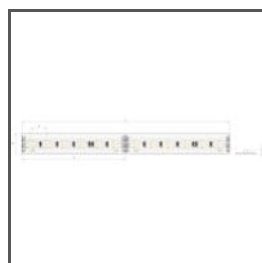

**K-1920-120-RGB-24V**  
K-1920-120-RGB-24V



**WP-K-1920-120-RGB-24V**  
WP-K-1920-120-RGB-24V

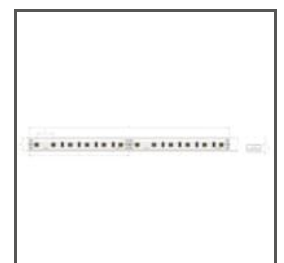

**WP-K-27/65-1920-24V**  
WP-K-27/65-1920-24V

# Profile TRIADA

Ref. B4476



**K-22/50-1728-24V**  
K-22/50-1728-24V

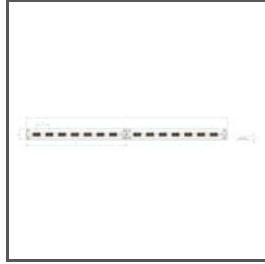

**K-30/18-1770-24V**  
K-30/18-1770-24V

## OTHER ACCESSORIES

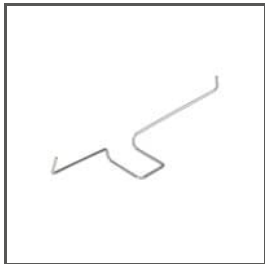

SPRING  
**TR**  
00801V1



FASTENER  
**PUSZ-LIN-ZD**  
42279, 42279L9010,  
42279L9005



FASTENER  
**PUSZ-PRET-ZD**  
42282, 42282L9010,  
42282L9005

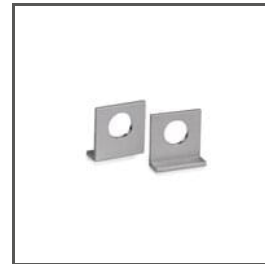

FASTENER  
**UCHO-ZD**  
42513



BLOCK  
**ZD**  
42521



CONNECTOR  
**ZD-180**  
43501



CONNECTOR  
**ZD-90**  
43502



CONNECTOR  
**ZD-PION-90**  
43504



CONNECTOR  
**ZD-PION-135**  
43505



FASTENER SET  
**RG-1**  
42647NI, 42647GSS,  
42647L9010, 42647L9005



GLAND  
**6x1,2**  
00802