

Profile REGULOR

Ref. B468+43

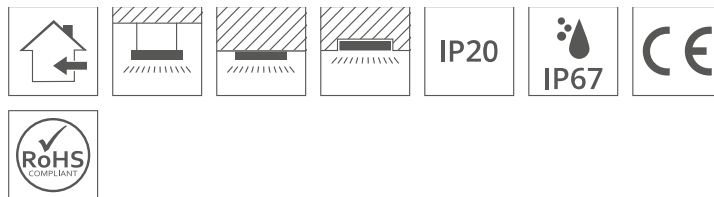

- Adjustable lighting angle
- Wide range of accessories

APPLICATION

- main and decorative lighting

MONTAGE

- to the surface, suspended or recessed, using dedicated accessories, properly selected screws, with double-sided adhesive tape or mounting adhesive
- easy assembly and disassembly by snapping in and out

ADDITIONAL INFORMATION

- thanks to the adjustable LED insert, the profile can be configured to obtain lighting angles of: 10, 30, 45, 60 or 90 degrees

TECHNICAL DRAWING

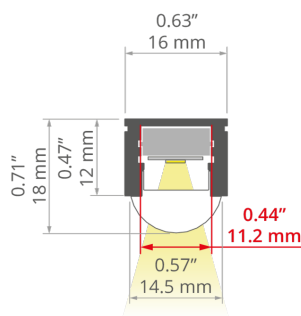

TECHNICAL SPECIFICATIONS

Material	aluminum	Length	Ref
Color	■ silver anodized	1000 mm	B468+43ANODA_1
With the possibility of sealing up to IP	20, 67	2005 mm	B468+43ANODA_2
Possible shapes of the luminaire	semicircular	3010 mm	B468+43ANODA_3
Beam angle adjustment from	10		
Beam angle adjustment up to	90		
LED gluing width A	11 mm		
Number of LED strips A (8 mm wide)	1		
Width	16 mm		
Easy assembly and disassembly by snapping in and out	yes		
The cover is cut to the length of the profile	yes		
Main lighting	yes		

Profile REGULOR





Ref. B468+43

Decorative lighting	yes
Wire out end cap	yes
Wire out back of extrusion	yes



SAMPLE PROJECTS



COVERS

NAME	MATERIAL	MATERIAL TRANSMITTANCE	COLOR	REF.
S	 PC	73	 clear	00220
S-SATYNA	 PC	67	 clear	17111

END CAPS

NAME	MATERIAL	COLOR	REF.
REGULOR	 PP	 gray	00310
REGULOR-OTW	 PP	 gray	00313

LED



8K-WP-K-1275-12V
8K-WP-K-1275-12V

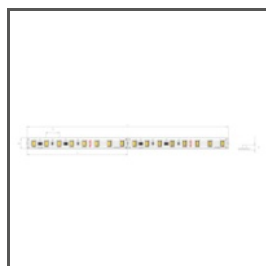

K-HE-0480-HD-24V
K-HE-0480-HD-24V

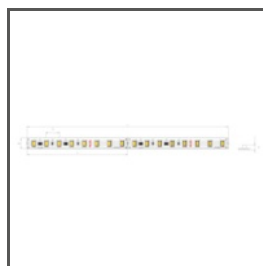

K-HE-0960-HD-24V
K-HE-0960-HD-24V

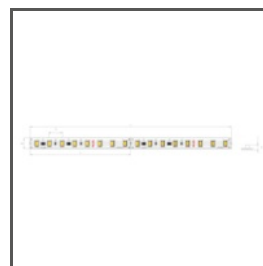

K-HE-1440-HD-24V
K-HE-1440-HD-24V



K-HE-1920-HD-24V
K-HE-1920-HD-24V

OTHER ACCESSORIES



MOUNTING BRACKET
PDS-STN
24190



MOUNTING BRACKET
REG-PD-UV
24270



MOUNTING BRACKET
PL-PDM
24041



MOUNTING BRACKET
PDS
1072, 24189, 24223



HEAD
ZZ
42218



HEAD
ZO
42217



HEAD
BZP-ZO
42214



HEAD
BZP-ZZ
42215



HEAD
ST
42216



HEAD
BZP
42213



ARM
K5G-AB
42051



FASTENER
PUSZ-PRET-MR
42252



FASTENER
PUSZ-LIN-MR
42258



FASTENER
FI-8-LIN-MR
42287, 42287L9010,
42287L9005



FASTENER
DP-ZZ
00651

Profile REGULOR

Ref. B468+43



FASTENER
DP-MOC-ZO
00646



FASTENER
DP-ZO
00649



FASTENER
DP-MOC-ZZ
00647



FASTENER
DP
00644



FASTENER SET
W1
42602



FASTENER SET
W2
42603



FASTENER SET
M3
42303



FASTENER SET
M4
42301



FASTENER SET
M5
42302



FASTENER SET
W6
42604



FASTENER SET
W7
42605



FASTENER SET
W9
42607

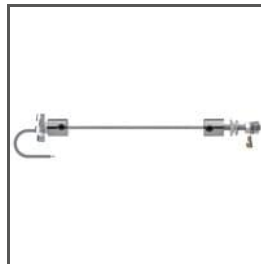

FASTENER SET
W10
42608



FASTENER SET
M11
42609



FASTENER SET
M12
42610

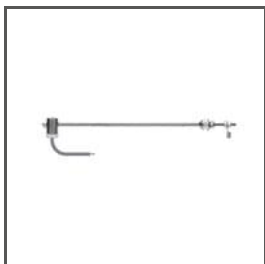

FASTENER SET
M13
42611

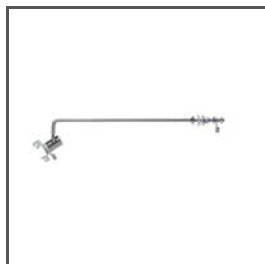

FASTENER SET
M14
42612



FASTENER SET
RG-1
42647NI, 42647GSS,
42647L9010, 42647L9005



GLAND
6x1,2
00802



MOUNTING BRACKET
PDS-STN-90G
24370



MOUNTING BRACKET
PDS-STN-90D
24367



MOUNTING BRACKET
PDS-STN-ALFA
24426

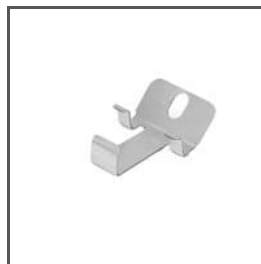

MOUNTING BRACKET
PDS-STN-45D
24456



MOUNTING BRACKET
PDS-STN-60D
24457