

Profile KOZMA

Ref. 18040

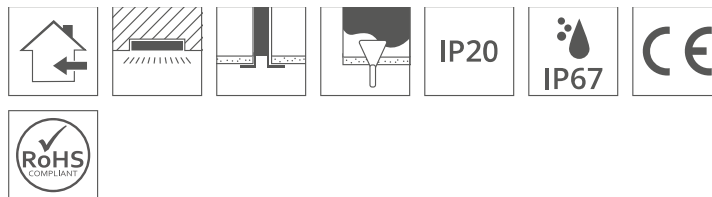
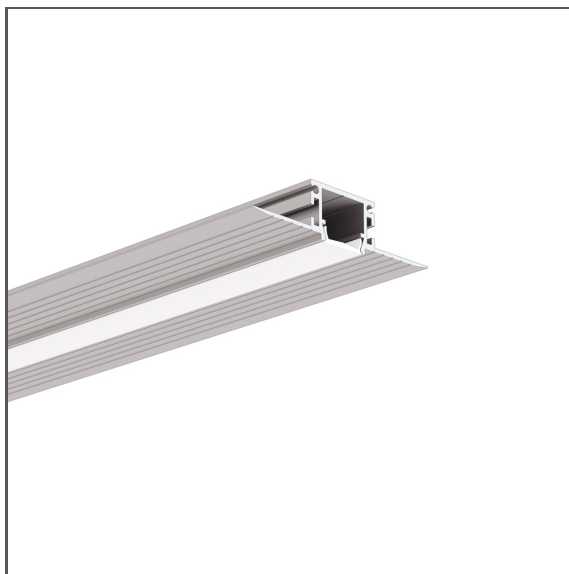

- Mounting to drywall
- No collision with the ceiling structure
- Line of light flush with the surface
- Non visible aluminum elements

APPLICATION

- main and decorative lighting

MONTAGE

- in drywall, with mounting adhesive
- can be easily connected into runs

ADDITIONAL INFORMATION

- in order to protect the lighting fixture during installation, a TECH-KA protective insert should be used

TECHNICAL DRAWING

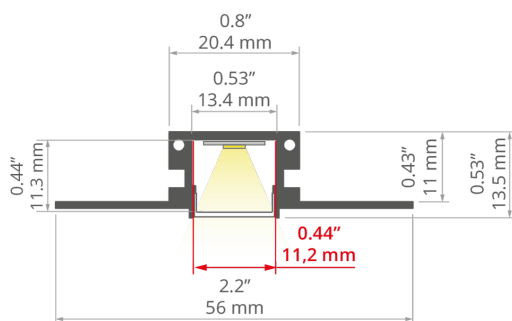

TECHNICAL SPECIFICATIONS

Material	aluminum	Length	Ref
Color	■ silver non anodized	1000 mm	18040NA_1
With the possibility of sealing up to IP	20, 67	2005 mm	18040NA_2
Possible shapes of the luminaire	polygonal	3010 mm	18040NA_3
LED gluing width A	11 mm		
Number of LED strips A (8 mm wide)	1		
Width	56 mm		
The cover is cut to the length of the profile	yes		
Can be easily connected into runs	yes		
Main lighting	yes		
Decorative lighting	yes		
Mounting to drywall	yes		

Profile KOZMA

Ref. 18040





To cover with plaster yes

Wire out back of extrusion yes

SAMPLE PROJECTS



COVERS

NAME	MATERIAL	MATERIAL TRANSMITTANCE	COLOR	REF.
KA		63	<input type="checkbox"/> frosted	17035
		91	<input checked="" type="checkbox"/> clear	17036
KA-PRO		67	<input type="checkbox"/> frosted	17064
		94	<input checked="" type="checkbox"/> clear	17065
HS		73	<input type="checkbox"/> frosted	1369
		94	<input checked="" type="checkbox"/> clear	1370
KA-COM		70	<input type="checkbox"/> frosted	17121
		93	<input checked="" type="checkbox"/> clear	17122
LIGER		70	<input type="checkbox"/> frosted	17037
		17037OP		
32	<input checked="" type="checkbox"/> black			17040

END CAPS

NAME	MATERIAL	COLOR	REF.
KOZMA		<input checked="" type="checkbox"/> gray	24217

LED

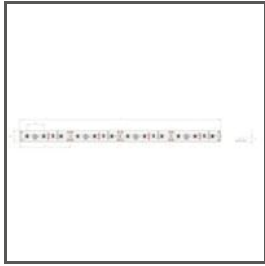

K-1210-12V
K-1210-12V

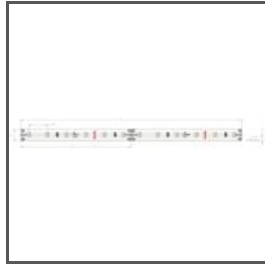

K-1210-24V
K-1210-24V



K-1220-12V
K-1220-12V

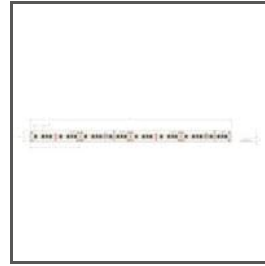

K-1220-24V
K-1220-24V



K-1275-12V
K-1275-12V



K-1275-24V
K-1275-24V

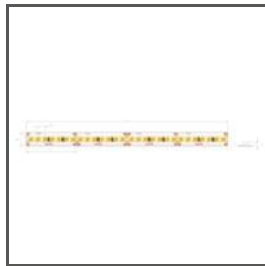

K-1820-HD-24V
K-1820-HD-24V

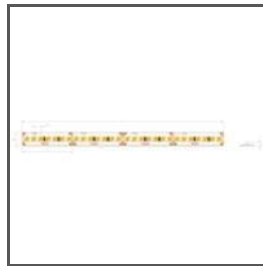

K-1910-HD-24V
K-1910-HD-24V



WP-K-1640-HD-IP65-24V
WP-K-1640-HD-IP65-24V



WP-K-1210-12V
WP-K-1210-12V

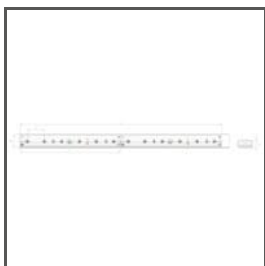

WP-K-1210-24V
WP-K-1210-24V



WP-K-1220-12V
WP-K-1220-12V



WP-K-1220-24V
WP-K-1220-24V

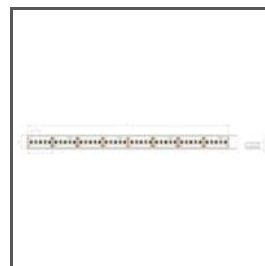

WP-K-1275-12V
WP-K-1275-12V



WP-K-1275-24V
WP-K-1275-24V



WP-K-1910-HD-IP65-24V
WP-K-1910-HD-IP65-24V



WP-K-1220-IP65-12V
WP-K-1220-IP65-12V



WP-K-1220-IP65-24V
WP-K-1220-IP65-24V

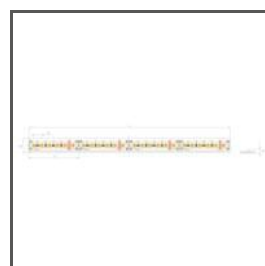

K-LR-1000-24V
K-LR-1000-24V



K-HE-0480-HD-24V
K-HE-0480-HD-24V



K-HE-0960-HD-24V
K-HE-0960-HD-24V



K-HE-1440-HD-24V
K-HE-1440-HD-24V



K-HE-1920-HD-24V
K-HE-1920-HD-24V

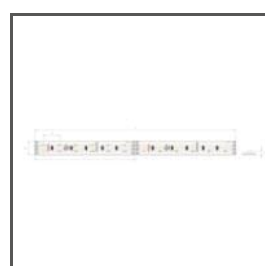

K-1275-RGB-24V
K-1275-RGB-24V



WP-K-1275-RGB-12V
WP-K-1275-RGB-12V

Profile KOZMA

Ref. 18040



K-1530-RGB+W-24V
K-1530-RGB+W-24V



K-1920-120-RGB-24V
K-1920-120-RGB-24V



WP-K-1920-120-RGB-24V
WP-K-1920-120-RGB-24V

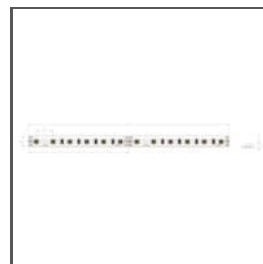

K-27/65-1920-24V
K-27/65-1920-24V

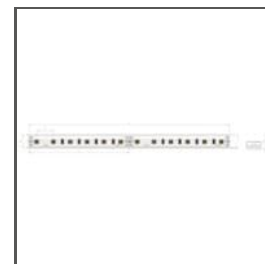

WP-K-27/65-1920-24V
WP-K-27/65-1920-24V



K-22/50-1728-24V
K-22/50-1728-24V

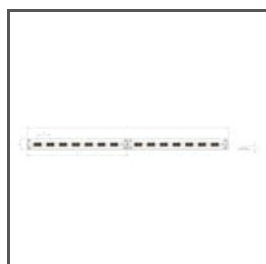

K-30/18-1770-24V
K-30/18-1770-24V

OTHER ACCESSORIES



CONNECTOR
ZM-NA-90
42723



CONNECTOR
ZM-NA-120
42729



CONNECTOR
ZM-NA-135
42725



CONNECTOR
ZM-NA-PION-135
42727

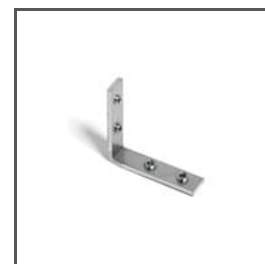

CONNECTOR
ZM-NA-PION-90
42726

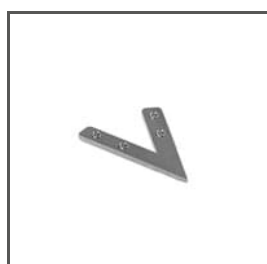

CONNECTOR
ZM-NA-45
42339

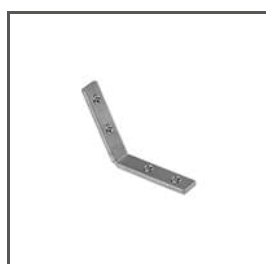

CONNECTOR
ZM-NA-PION-120
42321

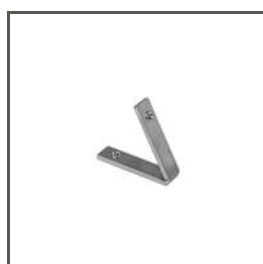

CONNECTOR
ZM-NA-PION-60
42317



CONNECTOR
ZM-NA-PION-45
42315



CONNECTOR
ZM-NA-180
42724

Profile KOZMA

Ref. 18040



GLAND
6x1,2
00802



PROTECTIVE INSERT
TECH-KA
17123



CONNECTOR
ZM-60
42736